

Installation and Operating Manual

NBU 190(t) (S) 24/PoE NTP Movement

Please read these instructions carefully before installation.



Product Certification

STANDARDS

The NTP movement NBU 190 was developed and produced in accordance with the EU Guidelines:

2006 / 95 / EC
2004 / 108 / EC
96 / 48 / EC



References to the Instruction Manual

1. The information in this Instruction Manual can be changed at any time without notice. The current version is available for download at www.mobatime.com.
2. This Instruction Manual has been composed with the utmost care, in order to explain all details in respect of the operation of the product. Please do not hesitate to contact us if you have any questions. Thank you for reporting any possible mistakes.
3. We do not answer for direct or indirect damages which could occur when using this manual.
4. Read the instructions carefully. Only start setting-up the product if you have understood the information for installation and operation.
5. The installation must only be carried out by skilled staff.
6. It is prohibited to copy this publication or to store it on a computer system. All rights reserved. Copyright © BÜRK MOBATIME GmbH D-78026 VS-Schwenningen / GERMANY and MOSER-BAER AG CH 3454 Sumiswald / SWITZERLAND.
7. **This manual is valid from the software version v1.17. For older versions, the manual BE 800695.04 is to be used.**



Guidelines for installation and handling

1. The movement may only be transported in the original packing and must be stored in a dry environment.

Content

1. Dimensions and definitions	4
2. Function description	5
3. Mounting guidelines	6
3.1 Mounting of movement series 190(t) (S)	6
3.2 Mounting of hands and starting-up	6
3.2.1 Mounting of hands	6
3.2.2 Starting-up and check of the hand positions	6
4. Configuration	7
4.1 Overview	7
4.2 Switches	7
4.2.1 Reset	9
4.3 Operation modes	10
4.3.1 Unicast	10
4.3.2 Multicast	10
4.3.3 Slave Mode	12
5. Operation details	13
5.1 Power supply	13
5.1.1 Current consumption	13
5.2 DHCP	13
5.3 IPv6	13
5.4 DHCPv6	13
5.5 Autokonfiguration / SLAAC	13
5.6 SNMP	14
5.7 Local time calculation	14
5.8 Accuracy / synchronization loss	15
5.9 Time source redundancy	15
5.9.1 NTP Client Unicast	15
5.9.2 NTP Client Multicast	15
5.10 MOBA-NMS (MOBATime Network Management System)	15
6. Update	16
6.1 Bootloader update	17
7. Connectors	18
8. Technical specifications	18
9. Time Zone Table	19

1. Dimensions and definitions

Diameter	Type	Art. No.
30 - 80 cm	Movement: NBU 190t S 24/PoE	203433
30 - 80 cm	Movement: NBU 190 S 24/PoE	204003
30 - 80 cm	Movement: NBU 190t 24/PoE	204004
30 - 80 cm	Movement: NBU 190 24/PoE	204005

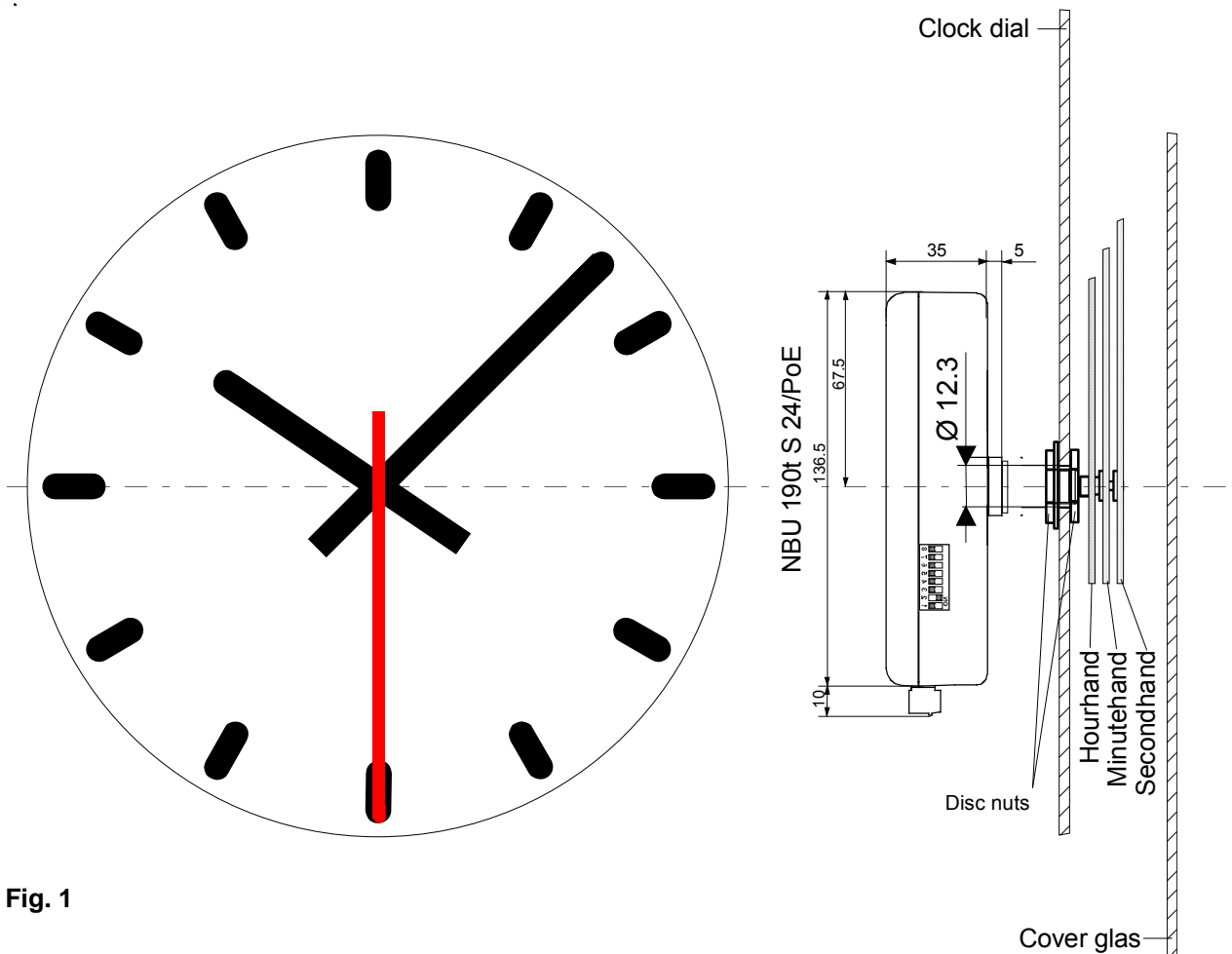

Fig. 1

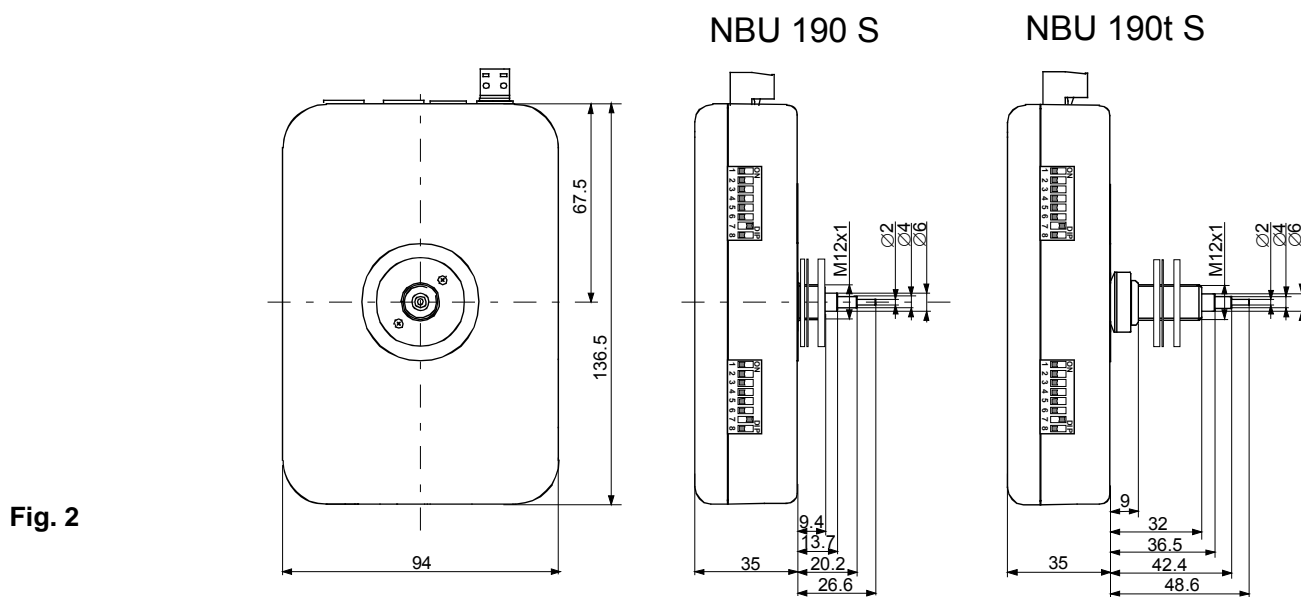

Fig. 2

2. Function description

The NBU 190 is a self-setting movement with hour, minute and second display. It is part of the family of xBU 190 movements and supplements it as NTP synchronized / network capable variant. The movement is suitable for indoor and outdoor slave clocks with dial diameters up to 800 mm. It is available for clocks with or without illumination.

Naming:

- NBU 190(t) (S) 24/PoE

Options:

- t Movement with long shafts for clocks with illumination
- S Movement with second shaft

Note: This document describes the functions for all available movement types (refer to table in chapter 1). Instructions concerning the operation of the second hand are only applicable for types with option S.

Features:

- 10/100 Mbit/s Ethernet LAN connection.
- Power supply PoE (Power over Ethernet) and/or DC input. Allows supply redundancy.
- Synchronization by a NTP server in the network.
- Cascade of up to three slave movements (I²C bus). Synchronisation, power supply and supervision by the master movement. For double or four sided clocks only one LAN connection is required.
- Operation mode selectable by means of 2 x 8 DIP switches.
- Automatic takeover of the network configuration:
 - IPv4: from a DHCP server in the network: IP address, gateway address, subnet mask, up to 4 NTP server addresses, time zone server address, SNMP manager address.
 - IPv6: -SLAAC: IP address
-DHCPv6 server in the network: IP address, up to 4 NTP server addresses, time zone server address, SNMP manager address

Alternatively: the network configuration can be set manually using the PC tool MOBA-NMS.

Alternatively use of a multicast IP address for synchronization / communication. Address selectable by means of DIP switches for minimum configuration effort.

Alternatively use of SNMP V2c for configurations.

- Automatic daylight saving time change according to a predefined daylight saving time rule (1 out of 64 rules selectable by means of DIP switches).
Alternatively automatic daylight saving time change according to a daylight saving time rule provided by a MOBATime time zone server in the network. (1 out of 15 rules selectable by means of DIP switches).
- Integration of the movement to a network management system (SNMP manager) supported: For supervision, master movements can send out SNMP V2c alarm and periodic alive traps and request them with GET/SET.
- Signalization of missing NTP synchronization after 24 hours by setting the hands to the 12:00 position.
- Different running modes of the second hand selectable by means of DIP-switches: Stepwise (wobbling) or continuous. Revolution within 58 s with stop at 12:00 position or revolution within 60 s without stop.

3. Mounting guidelines

3.1 Mounting of movement series 190(t) (S)

The dial must be sufficiently stable. The fixing hole must have a diameter of 12.3 mm. The movement must be fixed in vertical position.

Fig. 3 shows the positions of the mounting parts.

The disc nut (2*) M12 x 1 has to be tightened carefully with a special wrench tool (Art. No.: 201998) and a torque wrench with a torque of (4.5 +/- 0.2) Nm.

Caution:

The ring nut (5), the compensation ring (6) and the spring washer (7) must not be removed.

After tightening the disc nut (2*), the movement must not be wrenched!

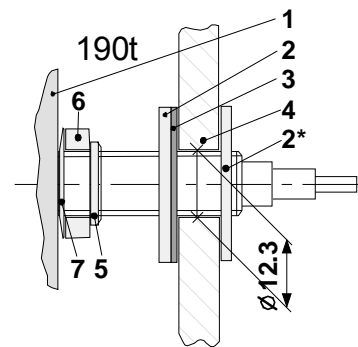

Fig. 3

- 1 Movement
- 2 Disc nut
- 3 Rubber washer
- 4 Dial
- 5 Ring nut
- 6 Compensation ring
- 7 Spring washer

3.2 Mounting of hands and starting-up

3.2.1 Mounting of hands

The shafts of the hour, minute and second hands are positioned ex-work on the reference position (12 o'clock). The hands must be carefully fixed and tightened on the shafts. Enough space must be provided between the hands. See Fig. 4.

The position 12 o'clock must be checked for each movement after mounting (see chapter 3.2.2).

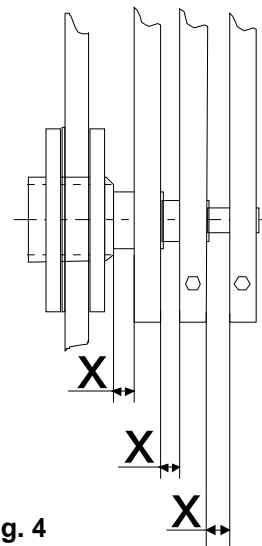

Fig. 4

3.2.2 Starting-up and check of the hand positions

- Set DIP switch 1.1 to ON position (12:00 position, refer to chapter 4.2).
- Either install a 24 VDC power supply and/or connect to PoE (Power over Ethernet). The clock runs to the 12:00 position.
 - ➔ Are the hands exactly positioned at 12:00 position?
- If any hand position is wrong the hands must be adjusted again (axis must not be moved).
 - ➔ Check the 12:00 position again (initialize procedure by interrupting the power supply or by disconnecting PoE respectively).
- If the hand position is OK continue with chapter 4 for further configuration.

4. Configuration

4.1 Overview

The NTP movement NBU 190 has three different operation modes:

- **Unicast**

The movement works as NTP Client and as a master movement. It has an own IP address. See chapter 4.3.1.

- **Multicast**

The movement works as NTP Client and as a master movement. It joins a group address (multicast IP address). See chapter 4.3.2.

- **Slave Mode**

The movement is working as a slave movement in the cascade and is controlled by a master movement. The slave movement has no network connection. See chapter 4.3.3.

Configuration takes place via two DIP switch groups located on the housing side of the movement (see chapter 4.2). The network configuration is automatically done by:

- IPv4: DHCP server (see chapter 5.2)
- IPv6: SLAAC or DHCPv6 Server (see chapter 5.3 and 5.5)
- manually using the PC tool MOBA-NMS (see chapter 5.10)

4.2 Switches

The movement has two switch groups (1 and 2). Each group contains 8 DIP switches.

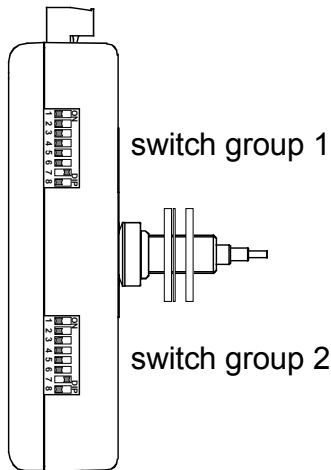

Definition of the switch positions:



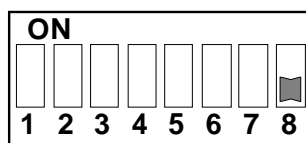



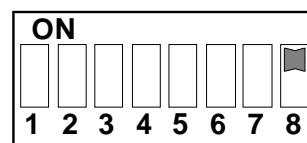

Switch Position OFF:

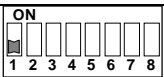
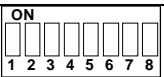
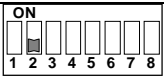
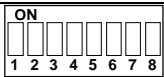

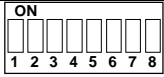
Switch Position ON:

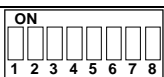

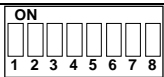
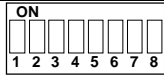
The following settings are possible:

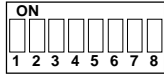
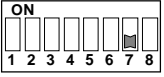
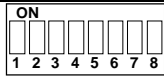
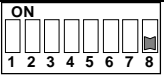
Switch:		Position OFF:	Position ON:
1.1	 1  2	Movement runs on time (if synchronized)	Movement runs to 12:00 position
1.2	 1  2	Second hand in stepwise (wobbling) mode	Second hand in continuous mode
1.3	 1  2	Second hand with stop at 12:00 (rotation time approximately 58 s)	Second hand without stop at 12:00
1.4	 1  2	Time zone from internal time zone table (selection 0..63 with switches 2.1 to 2.6)	Time zone table provided by time zone server (selection of entry 1..15 with switches 2.1 to 2.4)
1.5 to 1.8	 1  2	Unicast mode: 1.5: 0 1.6: 0 1.7: 0 1.8: 0	Multicast group address or slave address (binary value): 1.5: 1 1.6: 2 1.7: 4 1.8: 8
2.1 to 2.6	 1  2	Time zone (binary value)*: 2.1: 0 2.2: 0 2.3: 0 2.4: 0 2.5: 0 2.6: 0	Time zone entry from internal table or from list sent from time zone server (binary value): 2.1: 1 2.2: 2 2.3: 4 2.4: 8 2.5: 16 2.6: 32
2.7	 1  2	Multicast address range 239.192.54.1-15 resp. FF38::EFC0:3601-360F (selection 1..15 resp. 0x1-0xF with switches 1.5 to 1.8)	Multicast address range 239.251.34.1-15 resp. FF38::EFFB:2201-220F (selection 1..15 resp. 0x1-0xF with switches 1.5 to 1.8)
2.8	 1  2	Synchronization by NTP server in the network. Master mode.	Slave mode: Synchronization by master movement

* Internal time zone 0 = UTC. With external time zone server, the value 0 means “undefined”.

4.2.1 Reset

Most changes of the configuration switches cause the movement to restart (software reset). It is therefore recommended to set the switches correctly prior to applying power.

Switches 1.1 to 1.3 and 2.1 to 2.6 do not trigger a reset. All other switch changes lead to a restart (depending on the selected operation mode the movement needs to re-initialize).

If **all switches** are set to **ON position for 10 seconds** the movement executes a factory reset. All configuration settings will be **reset to default values**.

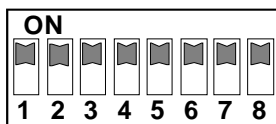

Switch group 1:



Switch group 2:

Default values:

Description (20 chars)	NTP Movement NBU 190
IP mode	IPv4 and IPv6 on
DHCP IPv4	on
IPv4 IP address	1.255.255.253
IPv4 subnet mask	255.255.255.0
IPv4 gateway address	1.255.255.252
IPv6 fix address/prefix	0::0/64
IPv6 link local address	see calculation in chapter 5.3
DHCPv6	on
IPv6 autoconfiguration (RA, SLAAC)	on
Host name	MOBATIMExxxxxx, with the last 6 digits corresponding to the last 6 digits of the MAC address. e.g. MAC 00:16:91:12:34:56 → MOBATIME123456
DNS server (for NTP server only)	0.0.0.0 / 0::0
NTP server address 1	0.0.0.0
NTP server address 2	0.0.0.0
NTP server address 3	0.0.0.0
NTP server address 4	0.0.0.0
NTP request interval [s] (10...999)	10
Configuration port number	65532
Time zone client port number	65534
DHCP support on/off	on
SNMP manager address 1	0.0.0.0 / 0::0
SNMP manager address 2	0.0.0.0 / 0::0
SNMP alive trap interval [min] (1...1440)	30

Additionally the NBU 190 can be reset by means of the PC tool MOBA-NMS.

4.3 Operation modes

4.3.1 Unicast

The movement has a network connection and is synchronized to UTC (Universal Time Coordinated) from a NTP server. It is able to control up to three cascaded slave movements over the I²C bus (synchronize, power and supervise).

This operating mode supports the monitoring and configuration of the movement via the network connection. Network parameters can be automatically obtained from a DHCP server or can be manually configured by means of the PC tool MOBA-NMS.

For supervision and configuration with MOBA-NMS one of the group addresses (multicast IP addresses) 239.192.54.0 or 239.251.34.0 for IPv4 resp. FF38::EFC0:3600 or FF38::EFFB:2200 for IPv6 or the IP address (selection with switch 2.7) is used.

The following switch settings select the operating mode Unicast (switches 1.5 to 1.8 and switch 2.8 in OFF position):

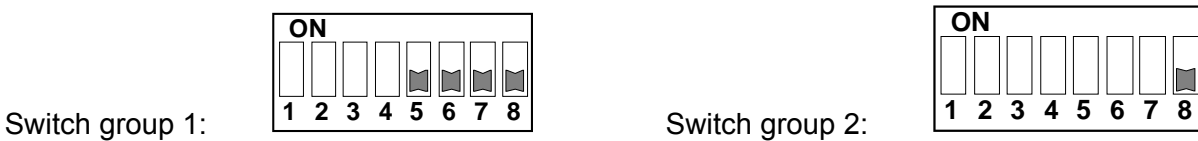

In this operating mode the movement will attempt to obtain the following network parameters from a DHCP server (see chapter 5.2):

- IP address
- Gateway address
- Subnet mask
- NTP server address(es) / Time zone server address
- SNMP manager address

In this operating mode, the clock will try to obtain the following network parameters in an IPv6 network from a DHCPv6 server (see also chapter 7.4):

- IP address
- NTP server address(es) / time zone server address
- SNMP manager address

The NTP server addresses must be configured by the network administrator as DHCP options on the DHCP server. If a server address was provided to the movement it will request time and time zone packets (switch 1.4 in ON position) from this server. The request interval can be configured with the PC tool MOBA-NMS.

4.3.2 Multicast

The movement has a network connection and is synchronized to UTC (Universal Time Coordinated) from a NTP server. It is able to control up to three cascaded slave movements over the I²C bus (synchronize, power and supervise).

Configuration can completely be done by means of the DIP switches on the movement (minimal configuration effort). Further this mode supports monitoring of the movement via the network connection. Single configuration parameters can be changed with MOBA-NMS via network.

For supervision and configuration with MOBA-NMS one of the group addresses (multicast IP addresses) 239.192.54.0 or 239.251.34.0 is used (selection with switch 2.7). The group address is an IP address in the multicast range (224.0.0.0 to 239.255.255.255), addresses selected by Moser-Baer AG from a freely available range:

-IPv4: 239.192.54.x and 239.251.34.x, whereat x = 1..15

With IPv6, the ranges mentioned above are implemented as follows:

-IPv6: FF3y::EFC0:360x and FF3y::EFFB:220x, whereat x = 0x1..0xF and y=scope

E.g.: 239.192.54.5 → FF38::EFC0:3605 or 239.251.34.10 → FF38::EFFB:220A

For scope, the following values are possible:

- 2 = Link Local Scope
- 5 = Site Local Scope
- 8 = Organization Local Scope
- 14 = Global Scope

In contrast to the Unicast mode, the movement receives multicast addressed time and time zone packets from a fixed server group address (multicast IP address). The standard port numbers are 123 (NTP) and 65534 (time zone). The Multicast operating mode signifies only a minimum amount of configuration work for a network administrator. The server group address is selected with the switches 1.5 to 1.8. In addition switch 2.7 allows selection of two different address ranges. The following settings are possible:

Switch 1:	Switch 2:	Group address	Switch 1:	Switch 2:	Group address
		239.192.54.1 FF38::EFC0:3601			239.251.34.1 FF38::EFFB:2201
		239.192.54.2 FF38::EFC0:3602			239.251.34.2 FF38::EFFB:2202
		239.192.54.3 FF38::EFC0:3603			239.251.34.3 FF38::EFFB:2203
		239.192.54.4 FF38::EFC0:3604			239.251.34.4 FF38::EFFB:2204
		239.192.54.5 FF38::EFC0:3605			239.251.34.5 FF38::EFFB:2205
		239.192.54.6 FF38::EFC0:3606			239.251.34.6 FF38::EFFB:2206
		239.192.54.7 FF38::EFC0:3607			239.251.34.7 FF38::EFFB:2207
		239.192.54.8 FF38::EFC0:3608			239.251.34.8 FF38::EFFB:2208
		239.192.54.9 FF38::EFC0:3609			239.251.34.9 FF38::EFFB:2209
		239.192.54.10 FF38::EFC0:360A			239.251.34.10 FF38::EFFB:220A
		239.192.54.11 FF38::EFC0:360B			239.251.34.11 FF38::EFFB:220B
		239.192.54.12 FF38::EFC0:360C			239.251.34.12 FF38::EFFB:220C
		239.192.54.13 FF38::EFC0:360D			239.251.34.13 FF38::EFFB:220D
		239.192.54.14 FF38::EFC0:360E			239.251.34.14 FF38::EFFB:220E
		239.192.54.15 FF38::EFC0:360F			239.251.34.15 FF38::EFFB:220F

4.3.3 Slave Mode

The Slave movement has no network connection. It is synchronized with local time and monitored by a Master movement (operating mode Unicast or Multicast possible). The cascade can help to reduce wiring effort since only one LAN connection is required. The disadvantage is that the slave movements cannot be addressed directly via a network connection. Monitoring is only possible via Master movement. Power supply in the cascade is only possible through the Master movement (with PoE or DC power supply). See chapter 5.1.

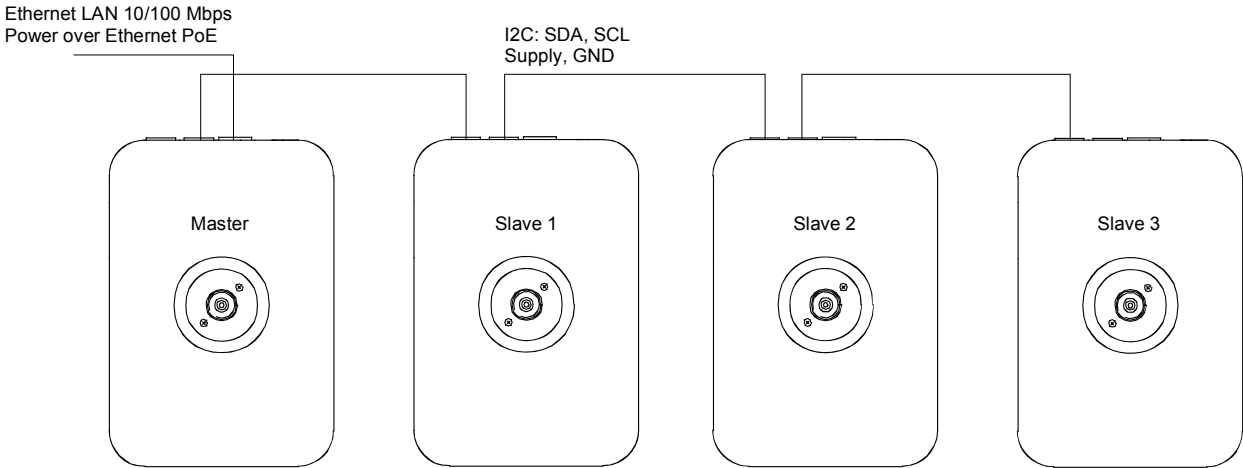

Figure 1: Max. 4 NBU 190 in cascade

Switch 2.8 must be set to ON position to operate the NBU 190 in Slave Mode. In addition an address 1..3 must be set by means of the switches 1.5 to 1.8 (Caution: each address 1..3 may only be used once!):

Switch 1:	Switch 2:	Address for Slave:
		1
		2
		3



The **cascading** connection may only be connected or disconnected in a **powerless** state of the master movement.



The Slave movements may only be powered through the cascading cable from the master movement. Additional DC power supply is not allowed.

5. Operation details

5.1 Power supply

The movement has a supply input for direct current +24 VDC. In addition, the NBU 190 can be powered by PoE (Power over Ethernet) from a switch. The variants of the power supply can be used individually or in combination.

The power supply is internally connected to the plug for the cascade. Only one source (connected to the master movement) is needed to power all movements of the cascade.

5.1.1 Current consumption

U [V]	With network connection		Without network connection	
	I _{min} [mA]	I _{max} [mA]	I _{min} [mA]	I _{max} [mA]
24	54	59	42	45

5.2 DHCP

If the movement operates in Unicast mode it automatically tries to obtain the network configuration from a DHCP server within the network. The DHCP options will be evaluated automatically.

The accurate description can be found in the manual BE 800793 Description MOBATime Network clocks.

The network administrator must configure the DHCP options accordingly.

5.3 IPv6

IPv6 allows for up to 4 parallel IP addresses, prioritized in decreasing order:

- address given by DHCPv6
- fix address
- address calculated with auto-config (SLAAC / RA)
- link local address

It is possible to deactivate DHCPv6 and / or auto-configuration.

Calculation of the link local address from the MAC address:

fe80::2[2nd part MAC]:[3rd part MAC]ff:fe[4th part MAC]:[5th part MAC][6th part MAC]

Example: MAC: 00:16:91:12:34:56
 ↓ ↓ ↓ ↓ ↓
 IPV6: fe80::216:91ff:fe12:3456

5.4 DHCPv6

In the unicast operating mode, the NPR tries to get the network configuration from a DHCPv6 server in the IPv6 network. The DHCP options are automatically evaluated.

A detailed description can be found in the manual BE-800793 Description MOBATIME network clocks.

The network administrator is responsible for configuring the DHCP options accordingly.

5.5 Autokonfiguration / SLAAC

In the unicast operating mode, the NPR tries to calculate the network configuration from the information of a router (RA) in the IPv6 network: IPv6 address.

A detailed description can be found in the manual BE-800793 Description MOBATIME network clocks.

5.6 SNMP

To allow an integration into a network management system, the NBU 190 supports SNMP version 2c. The definition is specified MOBANetClock.MIB. The manual BE 800793 shows the possibilities and use of SNMP.

5.7 Local time calculation

NTP movements are synchronized to UTC (Universal Time Coordinated). In order to calculate and display the current local time the movements require additional information. This information is provided by a so called time zone entry (daylight saving time rule). The NBU 190 has a pre-defined table with 64 entries. One of these entries can be selected using the switches 2.1 to 2.6 (Note: Switch 1.4 must be switched off to use the pre-defined table. See chapter 4.2).

The NBU 190 alternatively supports the calculation of local time based on the time zone entry provided by time zone server (switch 1.4 set to ON position). If the movement is operating in Unicast mode it will request the entry from the configured NTP server. If it is operating in Multicast mode it will receive the corresponding entry from the configured server group address (see chapter 4.3.2).

Only values 1 to 15 are valid settings. Otherwise the time zone is not defined.

Cascaded slave movements receive local time from the master movement. The switch settings are ineffective.

5.8 Accuracy / synchronization loss

In synchronized state the deviation typically is lower +/-50 ms.

The movements continues running autonomously for 24 hours without synchronization with quartz accuracy. After that the clock signalizes synchronization loss by setting the hands to 12:00 position and waiting for renewed synchronization. The deviation without synchronization after 24 h is typically lower +/-2 s (quartz accuracy: 20 ppm at room temperatures). Slave movements totally continue running for 48 hours without synchronization (timeout master + timeout slave).



Note: The mentioned deviations depend on the accuracy and ability of the time source (NTP server). NTP reception can be affected by network traffic and network devices (hubs, switches, routers, firewalls, etc.).

5.9 Time source redundancy

The availability of the time source in the network can be enhanced by redundant installation of NTP servers. Depending on the selected operation mode of the NBU 190 one of the following strategies is recommended (also adequate for time zone servers):

5.9.1 NTP Client Unicast

Up to four different NTP server addresses can be provided to the NBU 190 by means of DHCP/ DHCPv6 or the PC tool MOBA-NMS. If three NTP requests stay unanswered by the current NTP server the movement changes to the next server (if available). The duration until a change happens is depending on the configured NTP request time interval (default: 3 x 10 seconds). After a reset the movement sends the NTP requests to the first server.

5.9.2 NTP Client Multicast

Two NTP servers have to be installed sending out NTP packets on the same multicast address. The sending intervals of the servers have to be chosen in a ratio that synchronization in normal operation is done by the first server. Only in case of failure of the primary server the secondary server should take over synchronization. The ratio of the number of transmitted packets between primary and secondary server should be about 4:1:

- Sending interval primary server: 1 packet / 1 minute
- Sending interval secondary server: 1 packet / 4 minutes

The selection of the server hence depends on the dominance of the server with the shorter sending interval. If the primary server fails the secondary server thus becomes dominating.

5.10 MOBA-NMS (MOBATime Network Management System)

MOBA-NMS is a Java based PC program used for the configuration and status requests of NTP movements. This software allows for a central configuration of one or multiple devices.

Further informations, manuals and the software itself are available on our website <http://www.mobatime.com>. These are also available on a USB stick (must be ordered separately).



6. Update

The firmware resp. the bootloader of a clock can be updated using MOBA-NMS. However, depending on the reason for change the settings on the clock are lost. The protocol TFTP UDP Port 69 is used.

In the multicast operating mode, an update is carried out sequentially on multiple clocks. In the unicast operating mode, this is done parallel.



Attention: For the update, a DHCP server in the network is required.

The update window is opened by right-clicking on the device → Commands → Firmware Update...:

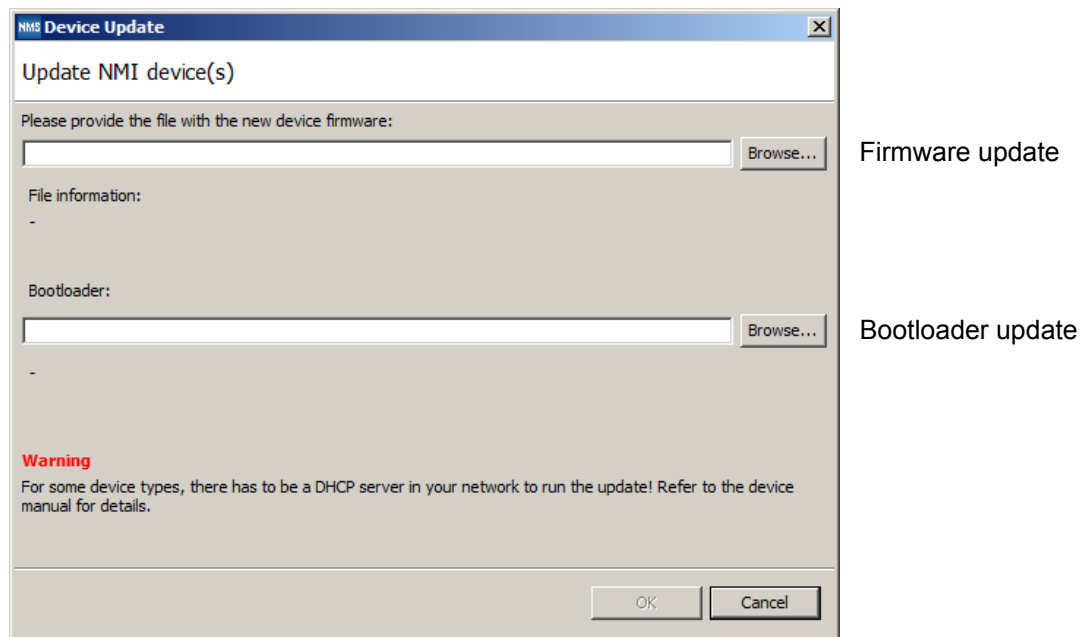

Attention: The newest versions of the firmware and bootloader are available at www.mobatime.com → Customer Area → Product Resources in the respective product folder. If the delivered device contains newer software than displayed in this manual, please check the settings.

6.1 Bootloader update

A bootloader update is only necessary if the respective alarm is displayed:

The image shows two overlapping windows from a management interface. The left window, titled 'Properties', displays the status of an NMI (PM') device. It shows a gauge with a red needle pointing to the 'Alarm' position. Below the gauge, it lists 'Status: Alarm' and 'Alarm(s): Bootloader'. A section titled 'Device Information (last connection)' provides details such as Type: NMI, Location / Description: PM', IP address: 10.241.0.151, Config. address: 10.241.0.151, Port: 65532, MAC address: 00:16:91:01:08:A0, and Host name: MOBATIME0108A0. It also shows the last status refresh time as Jul 13, 2015 3:01:53 PM and the next auto refresh in 2 min. 55 sec. An 'Open Configuration' button is visible. The right window, titled 'NMI (PM)', shows a detailed configuration page. It includes sections for 'Device Information' (Type: NMI, Location / Desc.: PM', Date: Jul 13, 2015, Status: Alarm, Run Mode: NTP Client Unicast, Time: 3:05:20 PM, Position: Normal, Output line mode: MOBALine, TZ Source: Local, Alarm(s): Bootloader, Second hand mode: Continuous with stop, TZ Entry: 2, Software: 204880.02.00, Minute hand mode: Stepwise, Last NTP time from: fd03:4432:4646:3454:0:0:0:2000), 'Device Information Network' (MAC Address, Multicast Address, Config. IP/Port, DNS Server, Host name, IP-Mode, DHCP, Auto conf, IP Address, Subnet Mask, DHCP V6, Gateway, DHCPv6 address, IPv6 link local, IPv6 address / Prefix, IPv6 Gateway), and 'MOBALine clocks status' (Clock ID 1 through 12, all set to 'Not configured'). A 'Refresh' button and 'Next refresh: 2 min. 46 sec.' are at the bottom right. Navigation tabs for 'Overview', 'General Settings', 'NMI Settings', and 'Time Zone Settings' are at the bottom left.

In case of a bootloader alarm, the selection field for the firmware (application) is deactivated and only made available after a successful bootloader update:

The image shows a dialog box titled 'NMS Device Update'. The main heading is 'Update NMI device(s)'. Below this, it says 'Please provide the file with the new device firmware:' followed by a text input field and a 'Browse...' button. Underneath, there is a 'File information:' section with a dash '-' and a 'Bootloader:' section with another text input field and a 'Browse...' button. At the bottom, there is a 'Warning' section with the text: 'For some device types, there has to be a DHCP server in your network to run the update! Refer to the device manual for details.' At the very bottom are 'OK' and 'Cancel' buttons.



Important: The bootloader file must be a .zip file.

7. Connectors

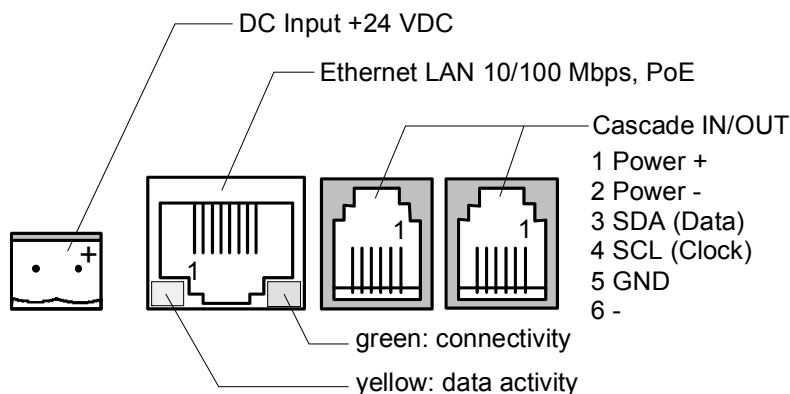

8. Technical specifications

	NBU 190(t)	NBU 190(t) S
Network interface	10/100 Mbit/s Ethernet controller, RJ45 connector Only shielded cable is allowed	
Network	IPv4 and / or IPv6 with: IPv4: static or DHCP IPv6: static, SLAAC and / or DHCPv6	
Synchronization	Network Time Protocol (NTP), UTC	
Supervision	State request with PC tool MOBA-NMS SNMP V2c alarm and alive traps for integration to a network management system	
Setting times: Running time to reference position and for daylight saving time changes	< 6 minutes	
Operation mode second shaft (Option S only)	- Continuous or stepwise (wobbling) - 1 revolution in 60 s or 1 revolution in 58 s with stop at 12:00 and start with the minute change	
Operation mode minute shaft	1 step every 60 s	
Operation mode hour shaft	continuous	
Power supply	PoE, phantom or pins 4,5, and 7,8 (Class 2) and/or DC Input +24 VDC +/-20 %	
Current consumption	< 60 mA at 24 VDC	
Calculation of local time and daylight saving time change	Automatic daylight saving time change according to 1 out of 64 pre-defined rules or automatic daylight saving time change according to 1 out of 15 rules provided by a MOBATime time zone server	
Accuracy	Deviation typically < +/-50 ms (synchronized)	
Synchronization loss	Signalization after 24 h by setting the hands to 12:00 position Deviation typically < +/-2 s after 24 h	
Number of motors	1 (hour / min.)	2 (hour. / min. + sec)
Temperature range	-30 ... +70 °C	
Weight	400 g	
Dial diameter	250 – 800 mm	
Maximum dial thickness	NBU 190: 4 mm NBU 190t: 14.5 mm	NBU 190 S: 4 mm NBU 190t S: 14.5 mm

9. Time Zone Table

Time zone entries of the standard time zone table (version 10.1).
The first 7 entries can be changed by MOBA-NMS.

Time zone	City / State	UTC Offset	DST Change	Standard → DST	DST → Standard
00	UTC (GMT), Monrovia, Casablanca	0	No		
01	London, Dublin, Edinburgh, Lisbon	0	Yes	Last Sun. Mar. (01:00)	Last Sun. Oct. (02:00)
02	Brussels, Amsterdam, Berlin, Bern, Copenhagen, Madrid, Oslo, Paris, Rome, Stockholm, Vienna, Belgrade, Bratislava, Bu- dapest, Ljubljana, Prague, Sarajevo, Warsaw, Zagreb	+1	Yes	Last Sun. Mar. (02:00)	Last Sun. Oct. (03:00)
03	Athens, Istanbul, Helsinki, Riga, Tallinn, Sofia, Vilnius	+2	Yes	Last Sun. Mar. (03:00)	Last Sun. Oct. (04:00)
04	Bucharest, Romania	+2	Yes	Last Sun. Mar. (03:00)	Last Sun. Oct. (04:00)
05	Pretoria, Harare, Kaliningrad	+2	No		
06	Amman	+2	Yes	Last Thu. Mar. (23:59)	Last Fri. Oct. (01:00)
07	UTC (GMT)	0	No		
08	Kuwait City, Minsk, Moscow, St. Petersburg, Volograd	+3	No		
09	Praia, Cape Verde	-1	No		
10	UTC (GMT)	0	No		
11	Abu Dhabi, Muscat, Tbilisi, Samara	+4	No		
12	Kabul	+4.5	No		
13	Adamstown (Pitcairn Is.)	-8	No		
14	Tashkent, Islamabad, Karachi, Yekaterinburg	+5	No		
15	Mumbai, Calcutta, Madras, New Delhi, Colombo	+5.5	No		
16	Astana, Thimphu, Dhaka, Novosibirsk	+6	No		
17	Bangkok, Hanoi, Jakarta, Krasnoyarsk	+7	No		
18	Beijing, Chongqing, Hong kong, Singapore, Taipei, Urumqi, Irkutsk	+8	No		
19	Tokyo, Osaka, Sapporo, Seoul, Yakutsk	+9	No		
20	Gambier Island	-9	No		
21	South Australia: Adelaide	+9.5	Yes	1 st Sun. Oct (02:00)	1 st Sun. Apr. (03:00)
22	Northern Territory: Darwin	+9.5	No		
23	Brisbane, Guam, Port Moresby, Magadan, Vladivostok	+10	No		
24	Sydney, Canberra, Mel- bourne, Tasmania: Hobart	+10	Yes	1 st Sun. Oct. (02:00)	1 st Sun. Apr. (03:00)
25	UTC (GMT)	0	No		
26	UTC (GMT)	0	No		
27	Honiara (Solomon Is.), Noumea (New Caledonia),	+11	No		
28	Auckland, Wellington	+12	Yes	Last Sun. Sep. (02:00)	1 st Sun. Apr. (03:00)

29	Majuro (Marshall Is.), , Anadyr	+12	No		
30	Azores	-1	Yes	Last Sun. Mar. (00:00)	Last Sun. Oct. (01:00)
31	Middle Atlantic	-2	No		
32	Brasilia	-3	Yes	3 rd Sun. Oct. (00:00)	3 rd Sun. Feb. (00:00)
33	Buenos Aires, Santiago	-3	No		
34	Newfoundland, Labrador	-3.5	Yes	2 nd Sun. Mar. (02:00)	1 st Sun. Nov. (02:00)
35	Atlantic Time (Canada)	-4	Yes	2 nd Sun. Mar. (02:00)	1 st Sun. Nov. (02:00)
36	La Paz	-4	No		
37	Bogota, Lima, Quito, Easter Island, Chile	-5	No		
38	New York, Eastern Time (US & Canada)	-5	Yes	2 nd Sun. Mar. (02:00)	1 st Sun. Nov. (02:00)
39	Chicago, Central Time (US & Canada)	-6	Yes	2 nd Sun. Mar. (02:00)	1 st Sun. Nov. (02:00)
40	Tegucigalpa, Honduras	-6	No		
41	Phoenix, Arizona	-7	No		
42	Denver, Mountain Time	-7	Yes	2 nd Sun. Mar. (02:00)	1 st Sun. Nov. (02:00)
43	Los Angeles, Pacific Time	-8	Yes	2 nd Sun. Mar. (02:00)	1 st Sun. Nov. (02:00)
44	Anchorage, Alaska (US)	-9	Yes	2 nd Sun. Mar. (02:00)	1 st Sun. Nov. (02:00)
45	Honolulu, Hawaii (US)	-10	No		
46	Midway Islands (US)	-11	No		
47	Mexico City, Mexico	-6	Yes	1 st Sun. Apr. (02:00)	Last Sun. Oct. (02:00)
48	Adak (Aleutian Is.)	-10	Yes	2 nd Sun. Mar. (02:00)	1 st Sun. Nov. (02:00)
49	UTC (GMT)	0	No		
50	UTC (GMT)	0	No		
51	UTC (GMT)	0	No		
52	UTC (GMT)	0	No		
53	UTC (GMT)	0	No		
54	Scoresbysund, Greenland	-1	Yes	Last Sun. Mar. (00:00)	Last Sun. Oct. (01:00)
55	Nuuk, Qaanaaq, Greenland	-3	Yes	Last Sat. Mar. (22:00)	Last Sat. Oct. (23:00)
56	Qaanaaq, Greenland (old)	-4	Yes	2 nd Sun. Mar. (02:00)	1 st Sun. Nov. (02:00)
57	Western Australia: Perth	+8	No		
58	Caracas	-4.5	No		
59	CET standard time	+1	No		
60	Santiago, Chile (old)	-4	Yes	2 nd Sun. Oct. (00:00)	2 nd Sun. Mar. (00:00)
61	Chile, Easter Island (old)	-6	Yes	2 nd Sat. Oct. (22:00)	2 nd Sat. Mar. (22:00)
62	Baku	+4	Yes	Last Sun. Mar. (04:00)	Last Sun. Oct. (05:00)
63	UTC (GMT)	0	No		
64	UTC (GMT)	0	No		

In countries where the DST switch date changes annually (e.g. Iran, Israel), the time zone has to be defined manually in the user time zone table (entries 80 – 99).

Legend:

UTC: Universal Time Coordinate, equivalent to GMT
DST: Daylight Saving Time
DST Change: Daylight Saving Time changeover
Standard → DST: Time change from Standard time (Winter time) to Summer time
DST → Standard: Time change from Summer time to Standard time (Winter time)

Example:

2nd last Sun. Mar. (02:00) Switch over on the penultimate Sunday in March at 02.00 hours local time.



Note:

Usually the time zone table is adapted each year. You can download the latest time zone table at our homepage: www.mobatime.com → Downloads → Customer support → Support Resources → Software Tools → Time Zone Table. If the delivered device contains a newer version than printed in this manual please check the time zone entries.

HEADQUARTERS / PRODUCTION

MOSER-BAER AG
Spitalstrasse 7, CH-3454 Sumiswald
Tel. +41 34 432 46 46 / Fax +41 34 432 46 99
moserbaer@mobatime.com / www.mobatime.com

SALES WORLDWIDE

MOSER-BAER SA EXPORT DIVISION
19 ch. du Champ-des-Filles, CH-1228 Plan-les-Ouates
Tel. +41 22 884 96 11 / Fax + 41 22 884 96 90
export@mobatime.com / www.mobatime.com

SALES SWITZERLAND

MOBATIME AG
Stettbachstrasse 5, CH-8600 Dübendorf
Tel. +41 44 802 75 75 / Fax +41 44 802 75 65
info-d@mobatime.ch / www.mobatime.ch

MOBATIME SA
En Budron H 20, CH-1052 Le Mont-sur-Lausanne
Tél. +41 21 654 33 50 / Fax +41 21 654 33 69
info-f@mobatime.ch / www.mobatime.ch

SALES GERMANY, AUSTRIA

BÜRK MOBATIME GmbH
Postfach 3760, D-78026 VS-Schwenningen
Steinkirchring 46, D-78056 VS-Schwenningen
Tel. +49 7720 8535 0 / Fax +49 7720 8535 11
buerk@buerk-mobatime.de / www.buerk-mobatime.de